

K&K Single point swing # 040720001

1x [1060844]
Cross section incl. bearing of Pendulum Swing

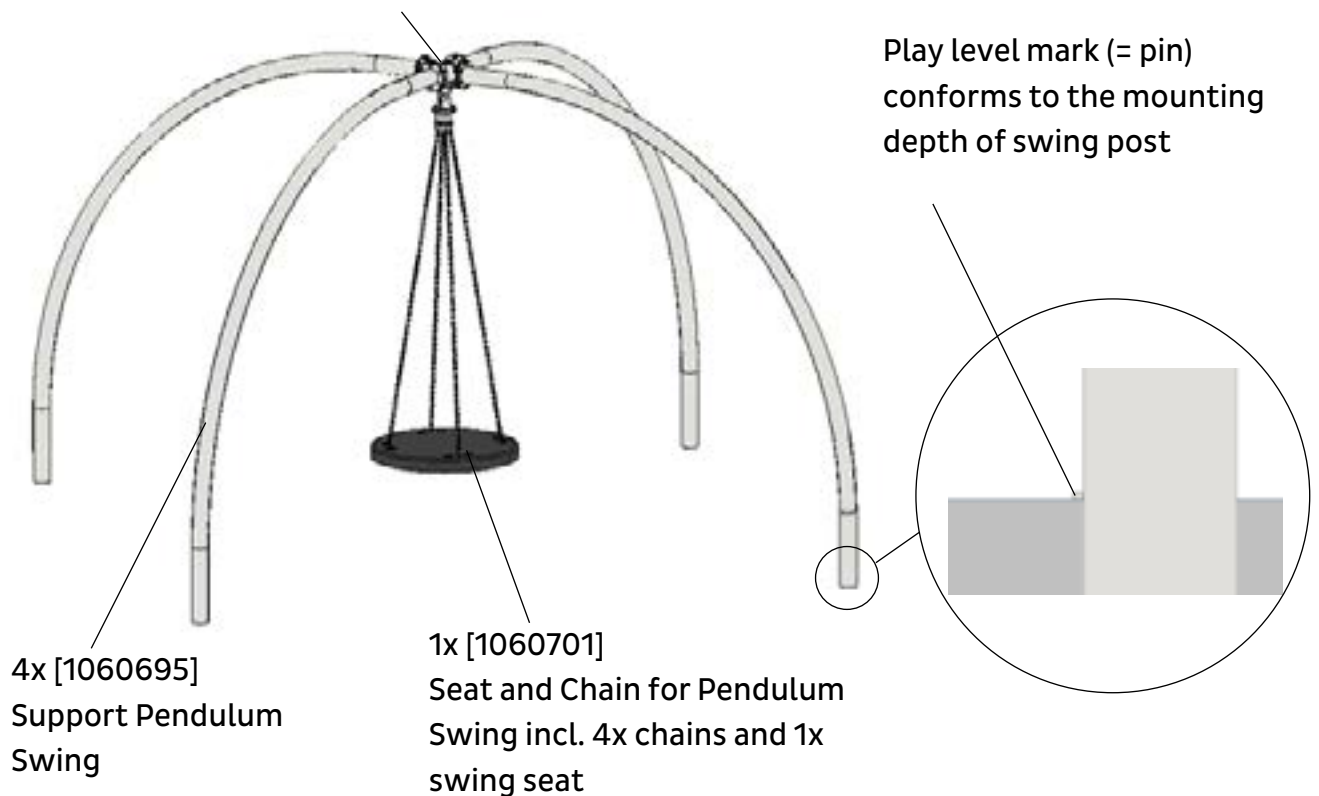

K&K Single point swing # 040720001	1
Instruction	3
Spaces and areas	4
Equipment installation	5
Foundation	6
Final assembly	7
Instructions for professional inspection and maintenance of single-point swings	8
One-time maintenance work	9
Regular maintenance	9
1. Routine visual inspection	9
2. Operational inspection	9
3. Annual main inspection	10
4. Endurance of the rotating swivel	11
Appendix A1	12
Visual inspection of swivel at least once a month:	12
Appendix A2	13
Replace lubrication at least every 6 months	13
Annexion E1	14
Spare parts	14

Instruction

1. Assign location of equipment considering the minimum space requirements (impact area).
2. Excavate soil for foundations, according to drawing. Please note: To achieve maximum stability and a safe installation, a moderate level of soil solubility is required.
3. Pour in a drain layer of gravel of approx. 10 cm thickness between the bottom of the swing posts and plain base of foundation.
4. At first, mount two opposite swing posts to the junction, according to drawing. Raise the unit by using an appropriate lifting gear.
5. Afterwards, mount the remaining two posts to the junction, place the whole unit into the foundation holes and align item horizontally considering the play level marks on the inner surface of the swing posts for installation depth.
6. Grout foundations with compressed concrete C20/25, chamfer and round off the edges and cover with a surface which meets the requirements for impact attenuation so that the critical fall height of the surfacing is equal to, or greater than, the free height of fall (cf. EN 1176-1).
7. CAUTION: Inspection and maintenance of the foundations may require access to the foundations below the playing level (see also the maintenance instructions).
8. After concrete foundations have set, attach chains to the swivel of the universal joint of the swing axle as follows: (see detail).
 - Unscrew 4x dog point screw (M16-stainless steel) at the side of the swivel.
 - Pull out the U-link downwards.
 - Put the last chain link in the U-link.
 - The dog point screw has to be lubricated slightly with installation paste (lubricating metal [SFWZ0000014])!
 - Fix the U-link with the dog point screw.
 - If necessary, shorten length of chains in order to ensure minimum ground clearance of 0,50 m beneath the swing seat.
 - The dog point screws have to be hand tightened e.g. with an Allen key or a catch without overwinding.
9. Check all screw connections according to maintenance instructions after 4-5 weeks and retighten, if necessary.

Please ensure that all special tools (e.g. Allen key for secured Allen screws etc.) and all specific documents which are or may be useful for safety management acc. to EN 1176-7 (e.g. invoice, delivery note, order acknowledgement, installation instructions, maintenance instructions) are forwarded to the persons responsible.

Age range recommended: from 8 years / public playground

Particular tools: ladder / lifting gear

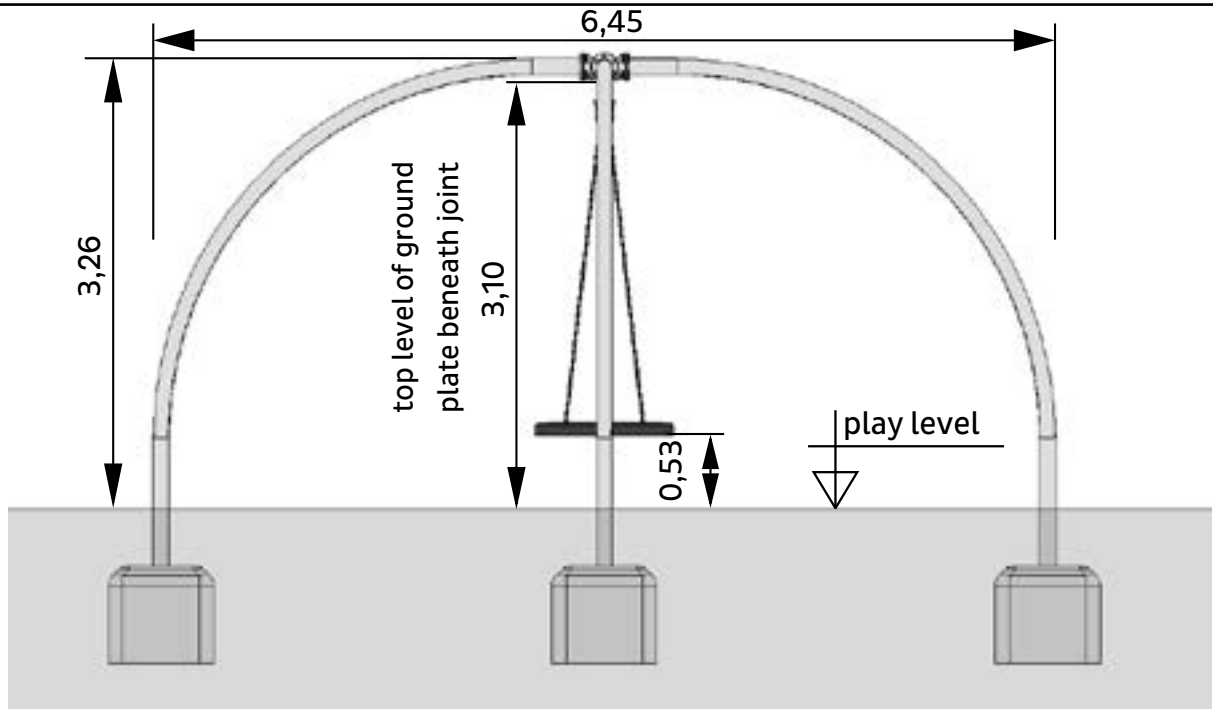

Spaces and areas

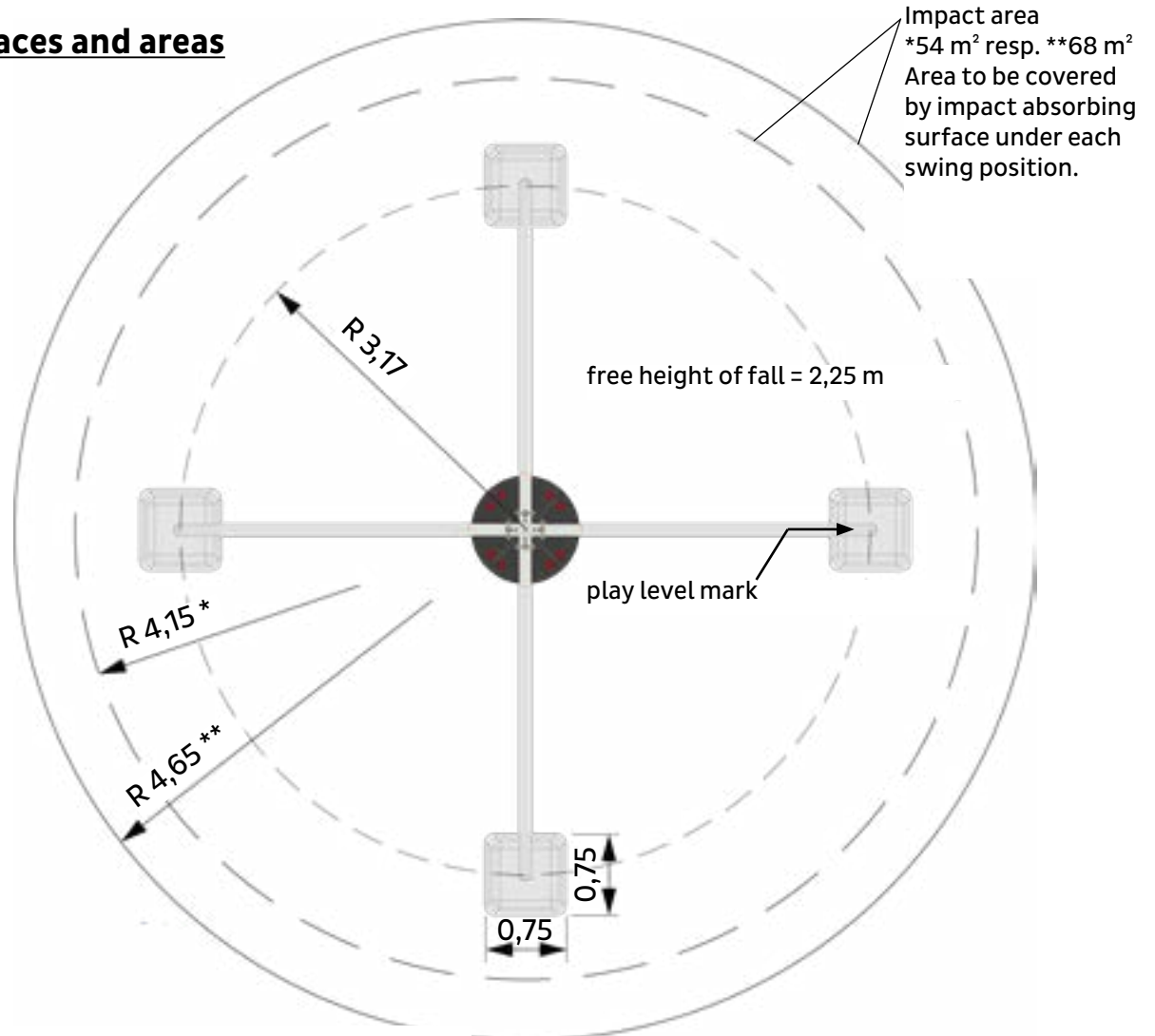

*) measure for synthetic surfacing with impact attenuating effect, level with the surrounding area. In swinging direction, an additional area of 0,50m length free from obstacles must be provided (cf. EN 1176-2:2008, 4.10.2.1).

**) measure for natural surface with impact attenuating effect, normally loose fill (cf. EN 1176-2:2008, 4.10.2.1)

Equipment installation

At first, mount two opposite swing posts to the junction, according to drawing. Raise the unit by using an appropriate lifting gear.

Afterwards, mount the remaining two posts to the junction, place the whole unit into the foundation holes and align item horizontally considering the play level marks on the inner surface of the swing posts for installation depth.

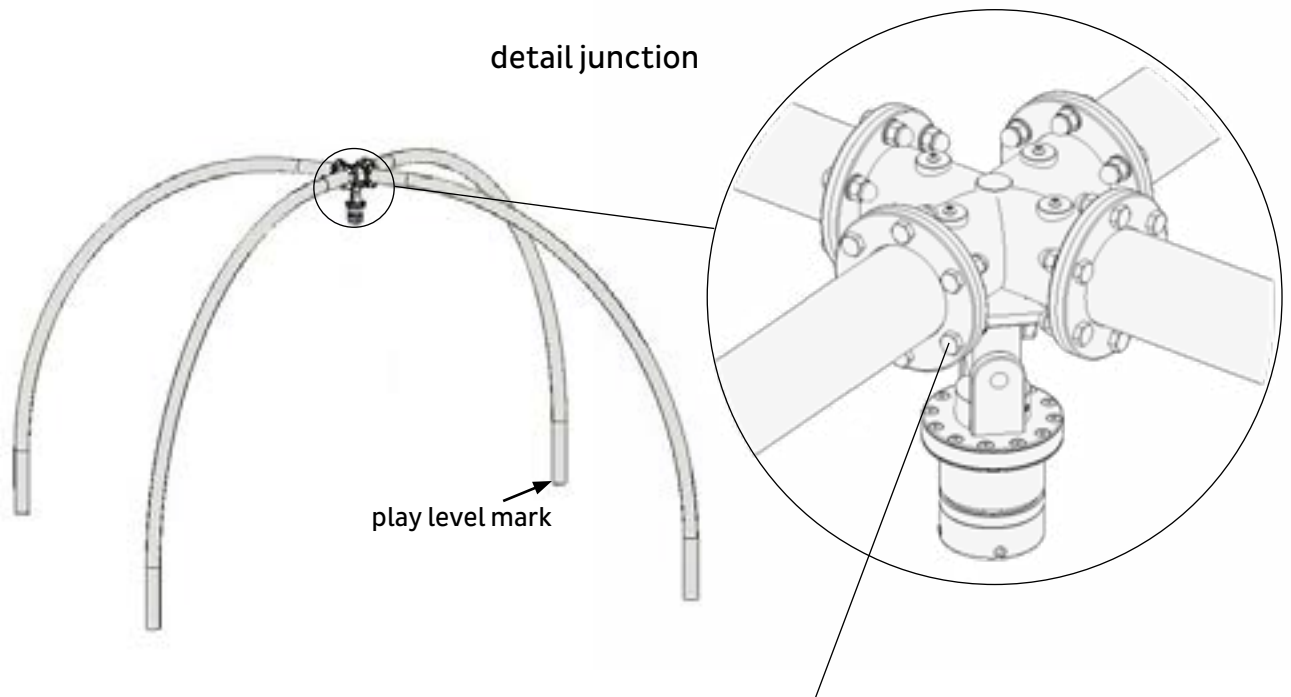

6x screw connection per swing post consisting of:

[3400199] Hexagon screw M16x40 galvanized steel

[3430019] Washer Ø 17mm

[3430053] Hexagon cap nut M16

Foundation

Foundations (on site)
 4x 0,75 x 0,75 x 0,70 m

(approximate) concrete needs
 1,6 m³

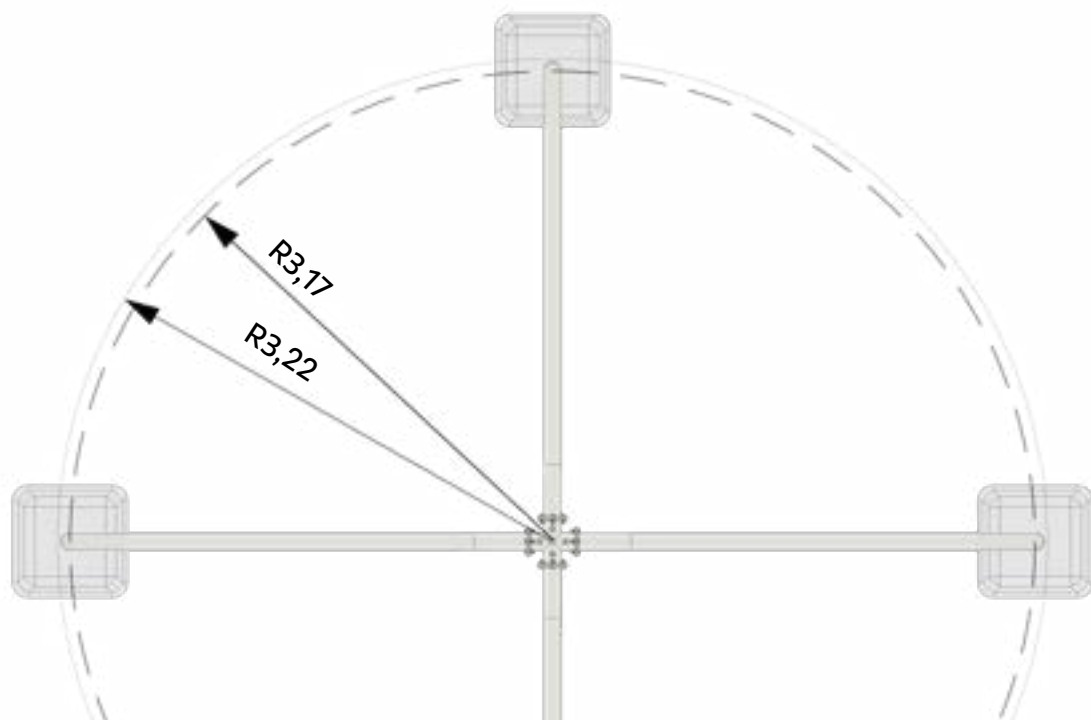
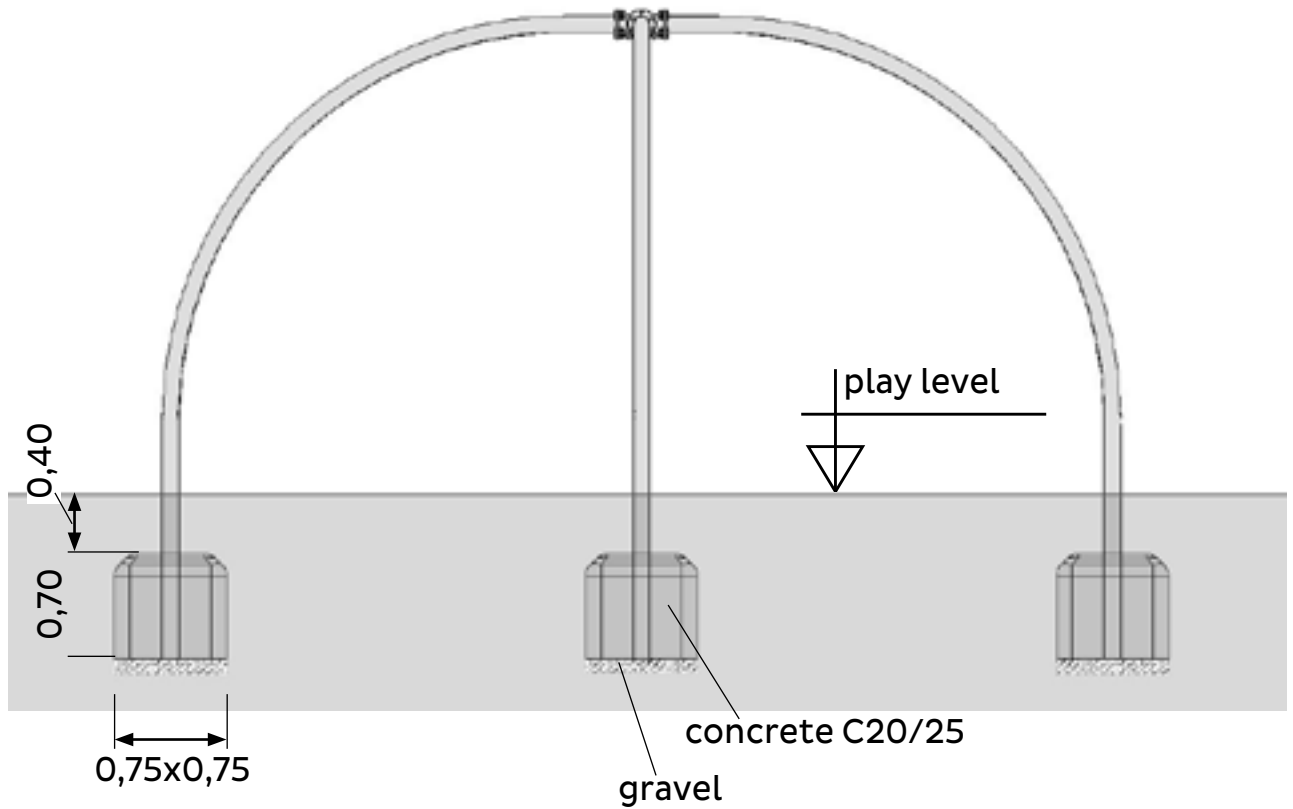

Final assembly

After concrete foundations have set, attach chains to the swivel of the universal joint of swing axle.

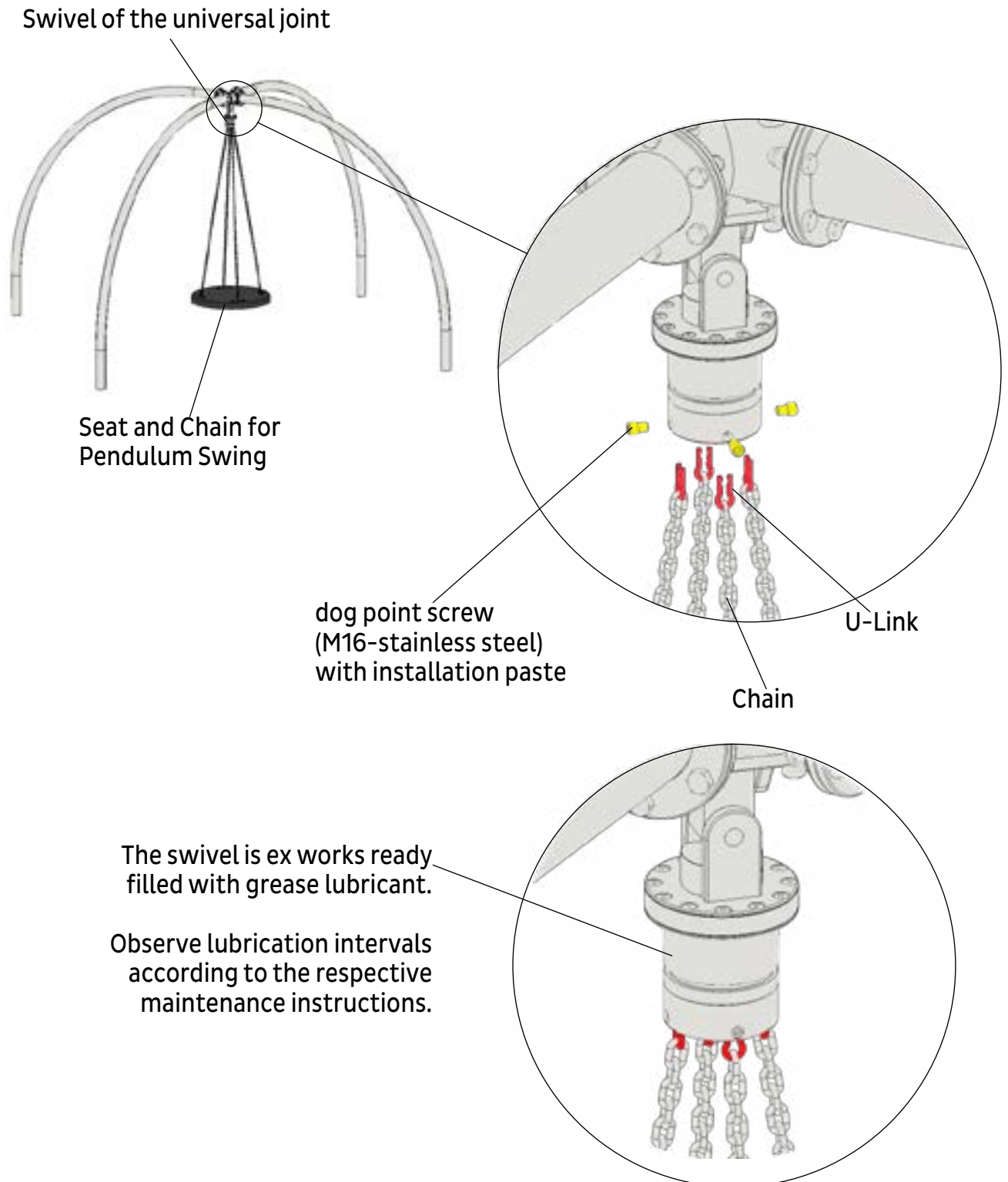

K&K Single point swing # 040720001**Instructions for professional inspection and maintenance of single-point swings**

Playground equipment is subject to a wide range of stresses and strains over the course of its useful life, which can reduce or even eliminate the original safety. Regular inspection and maintenance ensures that the required safety of playground equipment is maintained.

This maintenance manual contains all the instructions needed to perform the inspection tasks and to comply with the inspection periods. It is assumed in this maintenance manual that the playground equipment is installed in a normally frequented playground in normal surroundings. If there are local factors that deviate from the normal, the inspection periods must be adjusted. This may cause the time intervals specified by the manufacturer / distributor to be shortened. An extension of the time intervals is excluded as these are minimum requirements.

Among the local factors that require shortening of the inspection periods are, for example, locations with heavy use, e.g. schoolyards, kindergartens, amusement parks, location with high levels of vandalism, locations near the coast, locations with air pollution, playground equipment increasing age.

Furthermore, this maintenance manual assumes that the described inspections and maintenance work will be carried out by personnel with suitable qualifications. Certain tasks (such as welding) can only be performed by qualified professionals or require machining by the manufacturer / distributor.

The owner / operator of the playground should set up a suitable inspection plan for the playground and document the inspections and maintenance performed there for the particular playground equipment.

One-time maintenance work

Four weeks after installation, all screw connections must be checked and tightened if necessary. In this case, the specified advice in the regular maintenance work e. g. to turning moments has to be observed.

Regular maintenance

1. Routine visual inspection

1-1. 1x weekly (or different, determined by local factors)

- Check the minimum space of the playground equipment for cleanliness.
- Check playground equipment for consequences of vandalism, e. g. missing or damaged components.
- Check playground equipment for the effects of weather conditions, eg. B. by storm or frost.

2. Operational inspection

2-1. 1x monthly (or different, determined by local factors)

- Check for visibility of the warning groove (red-colored ring on the swivel housing). If the ring is visible in a horizontal direction, there is a need for repair. See appendix A1 „Visual inspection of swivel at least once a month“.
- Testing for smoothness of running. Relieve the swing platform and the universal joint from load. To check the swivel is slowly put into rotation by hand. If the swivel rotates without angular offset (well visible on the swing chains), it is fine and smooth of running.
- Check swing chains and connecting elements for wear, replace if necessary. Please note that the screws and nuts are fastened hand-tight without over-tightening the hexagon socket.
- Check plastic parts such as protective edges, linings, sheathing, sleeves, etc. for loss, signs of wear and damaged areas and replace if necessary.
- Check the condition of the ground surface, if applicable, follow the instructions for the inspection and maintenance of shock-absorbing floors specified by the manufacturer / distributor of playground floors, especially with regard to the level of loose fill material.
- Check the ground clearance of the swing platform.

2-2. every 3 months (or different, determined by local factors)

- Check axles, hubs and bearings for smooth running, bearing shake, wear or corrosion.
- Check for bearing play and wear. To check, the swing platform and the universal joint must be relieved by lifting the platform (e.g. by 2nd person or trestles). The swivel housing is manually set in motion to all directions. If wearout in excess of the intended swivel and rotary movements is detected damage requiring repair is present.

2-2. every 6 months (or different, determined by local factors)

- Check components for tight fit. Check screw connections and tighten if necessary. The instructions given in the regular maintenance work, e.g. regarding torques, must be observed.
- Replace lubrication as described in appendix A2 „Replace lubrication at least every 6 months“.

3. Annual main inspection

- Check playground equipment including all components and construction elements above and below the playing level for damage caused by wear, vandalism, weather events, rotting, corrosion and element formation, etc. This may require excavation or access to areas below the playground level and subsequent repair of the playground surfacing.
- Check foundations for damage due to wear, vandalism, weather events, rotting, corrosive and element formation, etc. This may require excavation or access to areas below the playing level and subsequent repair of the playground surfacing.
- Inspect the playground surfacing using the inspection procedures and maintenance instructions provided by the manufacturer/distributor of playground floors, particularly with regard to levels of loose fill material.

4. Endurance of the rotating swivel

- Dismount the swing joint of the playground equipment at the latest after a service life of 10 years and send it to the manufacturer/distributor for revision. It is assumed that the playground equipment is installed on a normally frequented playground in a normal environment. If the previous operational inspections have shown that local factors exist that deviate from normal, the life span must be adjusted. This can lead to a shortening of the service life specified by the manufacturer/distributor. An extension of the life span is excluded as this is the maximum duration.
- If damage is found to the swing joints, the affected play equipment must be taken out of service and must be closed until overhauled by the manufacturer/distributor or the swing joint is replaced. Access to the public, including children, must be prevented.

Appendix A1

Visual inspection of swivel at least once a month:

Check for visibility of the red-coloured warning groove

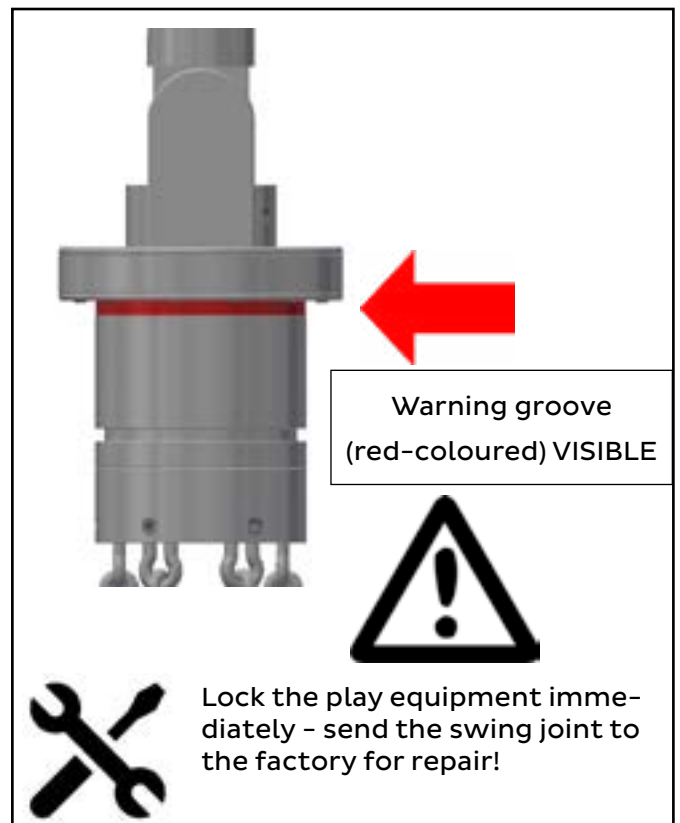
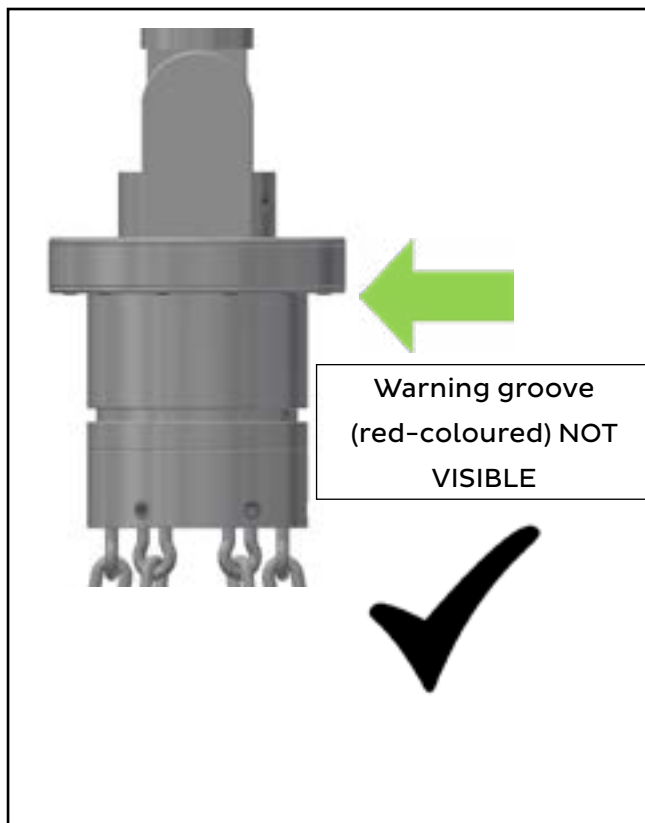
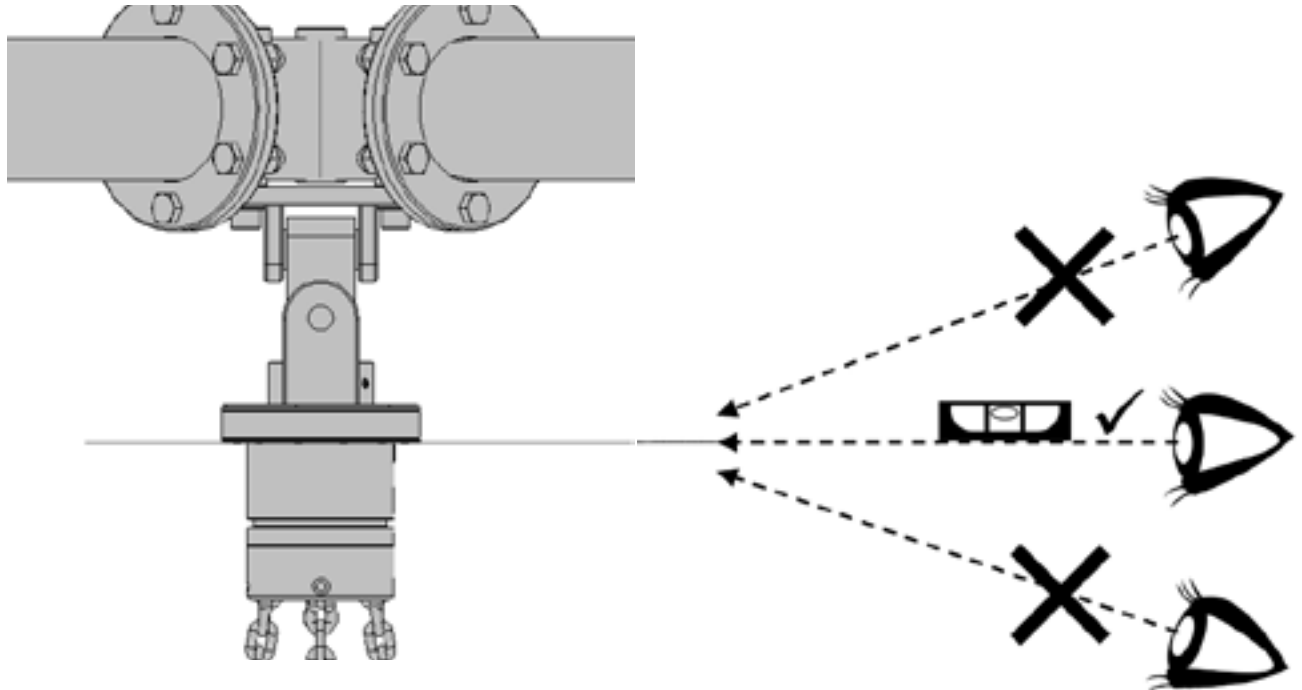

Dismount the swing joint of the playground equipment at the latest after a service life of 10 years and send it to the manufacturer/distributor for revision.

Appendix A2

Replace lubrication at least every 6 months

required equipment:

- Lever grease press for taper lubricating nipple (K&K item 5200732)
- Fluid grease for K&K swing joints (K&K item 5200733)
- Ladder
- Cleaning rags/paper towels
- Allen key (wrench size 5 mm)

The lubricant must comply with Kaiser & Kühne specifications.

Procedure:

Lube point 1:

1. Remove the screw plug 1 with an Allen key size 5 mm (do not lose the sealing ring).
2. Press lubricant into the grease nipple using a lever grease press until fresh lubricant emerges from bore 1.
3. Pick up escaping old lubricant with e.g. cleaning rags and dispose of it properly.
4. Insert screw plug 1 and tighten firmly.





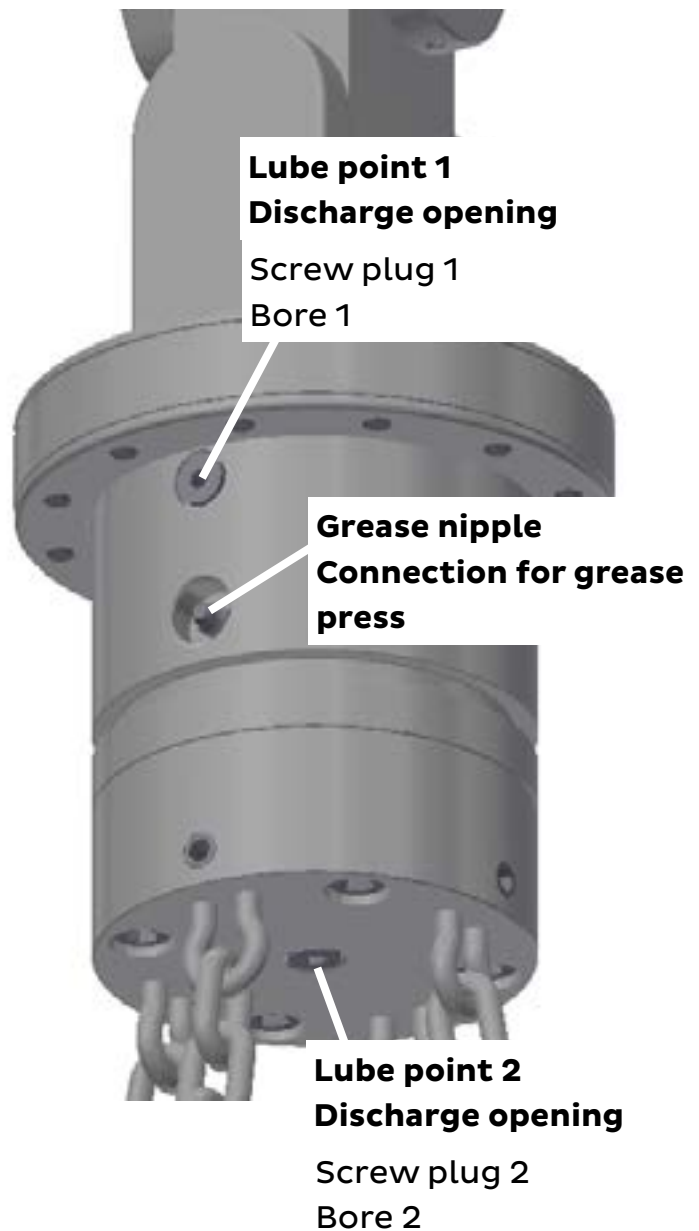

Lube point 2:

5. Remove the screw plug 2.
6. Press lubricant into the grease nipple using a lever grease press until fresh lubricant emerges from bore 2.
7. Pick up escaping old lubricant with e.g. cleaning rags and dispose of it properly.
8. Insert screw plug 2 and tighten firmly.









Annexion E1

Spare parts

Item no.	Quantity	Description	Image
1060695	4	Support Pendulum Swing	
1060844	1	Cross section incl. bearing of Pendulum Swing	
1060829	1	Universal joint with swivel (four chain strands)	
3400557	4	Cheese head screw M16x80	
3430060	4	Washer Ø17	
3490041	4	Hexagon stopple Alu 14 mm	
3400475	4	Dome head security screw-M8x12-Resistorx T40 A2	





Annexion E1

Spare parts

Item no.	Quantity	Description	Image
1060701	1	Seat and Chain for Pendulum Swing incl. 4x chains and 1x swing seat	
3590050	1	Single point swing seat	
015753	4x 2214 mm	Stainless steel chain Ø 7,0 mm	
1060742	4	U-Link 6 mm for 015818/3590050	
3430010	4	Hexagon cap nut M8 A2	
3430009	4	Washer Ø8,4 A2	
3400199	24	Hexagon screw M16x40 galvanized steel	

Annexion E1

Spare parts

Item no.	Quantity	Description	Image
3430019	24	Washer Ø 17mm	
3430053	24	Hexagon cap nut M16	
5200733	1	Fluid grease cartridge 400 g	
5200732	1	Lever grease press	
3490006	1	Allen key security hex socket AF5	
2030204	4	Dog point screw M16x25	
1060693	4	U-Link	
SFWZ0000014	1	Lubricating metal, bag (4 g)	